

PP

PORTAPOWER

PORTAPOWER

www.portapower.com

PORTAPOWER

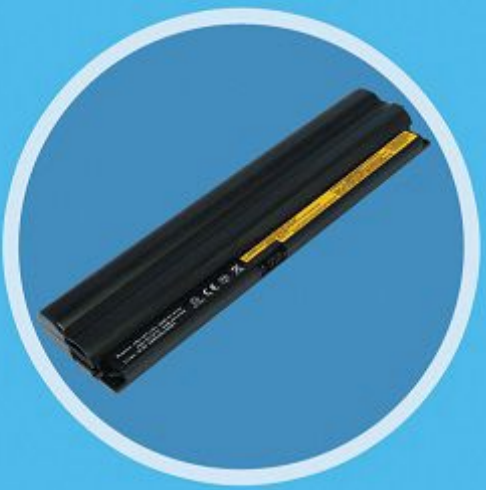

2013-09
Version



THE COMPANY

PortaPower was founded in 1995 with a mission of manufacturing and marketing high quality rechargeable batteries and related products to the customers worldwide. with its headquarter in Hong Kong, it has sales and administration, R&D offices, laboratories and factories in Hong Kong, China and Canada. The company has world-wide staff size of about 2000. Its factories in Shenzhen and Panyu is ISO 9001 certified, and have a total production



capacity of over 1,000,000 standard battery units per month. It offers approximately three thousand product models for customer's selection. PortaPower manufactures replacement batteries and related accessories and also develop and produce OEM items according to customer's requirements. Its products bear some of the world's most prestigious brands, including Duracell®, Energizer®, Rayovac® and others.

PortaPower has highly efficient production and assembly lines with the most modern equipment, like in-house machine tooling, injection welding lines and CNC mould production producing workshops, to ensure the timeliest response to rapidly changing market needs. And, PortaPower invests heavily on research and development. Its experienced R&D teams keep PortaPower in the forefront of rechargeable battery technology.

Among PortaPower's leading products are rechargeable battery packs for notebook computers, camcorders and digital cameras. The Li-ion cells used in these battery packs are procured from the most reputable manufacturers in Japan, Korea and China.

We have insured all our battery and charger products with a 2 million US Dollars (US\$2,000,000) world-wide product liability insurance.

 **ace insurance**

Date: 12 December, 2012

CERTIFICATE OF INSURANCE

This is to certify that the following insurance has been effected with this Company:

NAMED INSURED :	Portapower (HK) Limited
COVERAGE :	Commercial General Liability (Product Liability Coverage Only) per ACE's Advantage Occurrence Form on the following products:
PRODUCTS INSURED :	Battery Packs and Battery Chargers.
LIMIT OF LIABILITY :	US\$2,000,000.00 Anyone Occurrence & US\$2,000,000.00 in Aggregate during the Period of Insurance.
PERIOD OF INSURANCE :	From : November 08, 2012 To : November 07, 2013 (Both Dates Inclusive)
POLICY TERRITORY :	Worldwide
JURISDICTION :	Worldwide
SPECIAL CONDITION :	- 30 Days' Cancellation Clause.
INSURER :	ACE Insurance Limited (Subsidiary Company of Insurance Company of North America, AM Best #02259)
POLICY NO.:	HCP0576948/12

In term of our credit arrangements with the Insured, the premium under the said Policy will be paid as arranged and the risk insured is covered by this Company subject to the terms and conditions of the said Policy. This Certificate is issued as a matter of information only and does not amend, extend or alter the coverage of the said Policy.

For and on behalf of
ACE INSURANCE LIMITED

AUTHORIZED SIGNATURE

DOC: PortPower48C (270)

Local : 25/F, Shui On Centre, No. 6-8 Harbour Road, Wanchai, Hong Kong. (E-mail address: Causality.HK@acegroup.com)
In U.S.A. : ACE USA Claims PO Box 5113 Scranton, PA 18505-0530, USA

POWER TO THE PORTABLE

**LAPTOP, NETBOOK, ULTRABOOK
BATTERY PACKS**



**CORDLESS POWER TOOLS
BATTERY PACKS**

**DIGITAL CAMERA &
VIDEO CAMCORDER
BATTERY PACKS**



**MOBILE, SMARTPHONE &
PDA BATTERY PACKS**

**REPLACEMENT
LED-FLASHLIGHT BATTERY**

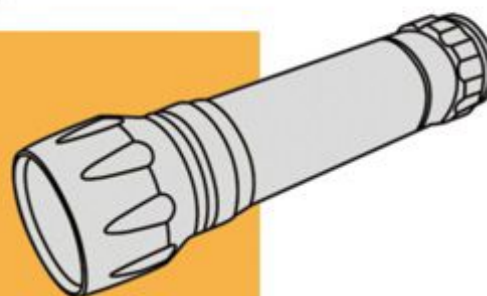

EXTERNAL BATTERY PACKS



UNIVERSAL LI-ION CHARGERS



LAPTOP, NETBOOK BATTERY PACKS



For HP



For Samsung



For Toshiba



For Dell



For Lenovo



For Acer



For Sony



For Fujitsu

We provide a broad range of brands to choose:

Acer, Apple, Asus, BenQ, Dell, LG, Compaq, Fujitsu, Gateway, Sony, Kohjinsha, Lenovo, Samsung, MSI, Panasonic, Toshiba, HP, IBM, etc.

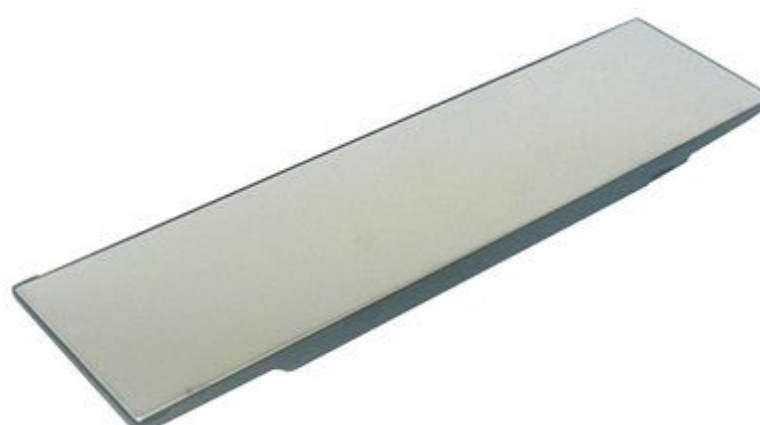

For Asus



For MSI

ULTRABOOK BATTERIES



For Dell



For Sony



For Acer



For HP

Matching original OEM laptop battery design, our laptop batteries also have Secondary Safety Protection Circuit.

PRIMARY PROTECTION CIRCUIT

Senses the voltage level and disable the charge circuit after a predetermined voltage level is exceeded for a specified time period. In the event that the cell voltage exceeds its maximum level, the cell can enter a thermal runaway condition where the cell temperature can exceed 125°C. At this temperature the cell may explode and erupt into flames.

SECONDARY PROTECTION CIRCUIT

With Thermal and Current Fuse, to prevent over-voltage, short circuit and thermal runaway conditions in the event the Primary Protection Circuit does not operate properly.

Safety Protection



Circuit Board with Secondary Protection

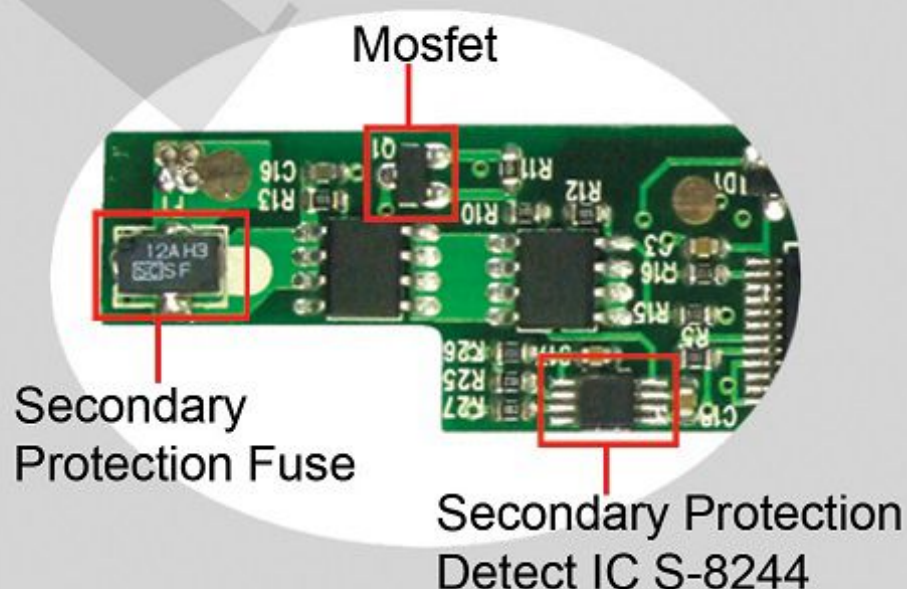

Circuit Board without Secondary Protection

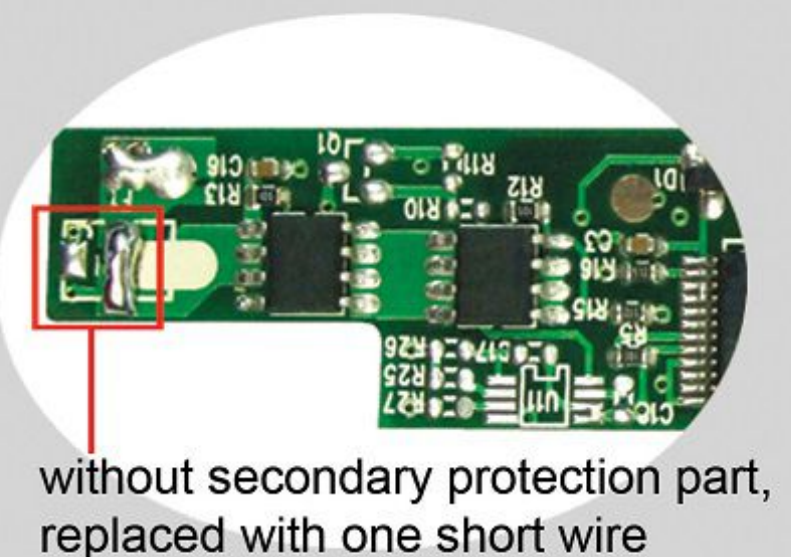



UNIVERSAL LAPTOP AC & DC ADAPTERS

Interchangeable Connector Tips

We provide 38 kinds of tip to choose. Select a suitable connector tip and fits into the laptop DC-in jack tightly and steady. Then connect the DC output of the Power Adapter to the connector tip.



Universal Laptop AC Adapters

AC Power Adapters

15V / 5.33A
80W



50.8 x 31.4 x 128.2 mm

16V / 3.75A
60W



59 x 31.2 x 134 mm

16V / 4.06A
65W



95.41 x 42.3 x 30.44 mm

19V / 2.36A
45W



90.6 x 35.94 x 26.04 mm

19V / 4.74A
90W



58.5 x 34.5 x 134 mm

19V / 7.9A
150W



70.7 x 41.4 x 170.4 mm

20V / 6A
120W



60 x 37 x 152 mm

24V / 1.9A
45W



44.4 x 28.2 x 96.7 mm

UNIVERSAL LAPTOP AC & DC ADAPTERS

DC Auto Adapters

Model: DC092B.005
 Input: DC 12V - 15V
 Fuse: 15A
 Output: 15-17V / 5.3A Max.
 USB Output: DC 5V / 1A Max.
 Max. Output Power: 90W
 Size: 106 x 51 x 18 mm
 Cord Length: 1200 mm

Model: DC092B.006
 Input: DC 12V - 15V
 Fuse: 15A
 Output: 19-20V / 4.7A max.
 USB Output: DC 5V / 2.1A Max.
 Max. Output Power: 90W
 Size: 106 x 51 x 18 mm
 Cord Length: 1200 mm



New Design



Universal Laptop DC Adapters

Special Charging Design

- **Dual USB Output Ports**
 - Output I: 5V / 1A Max.
 - Output II: 5V / 2.1A Max.
- **Able to charge 3 devices simultaneously**

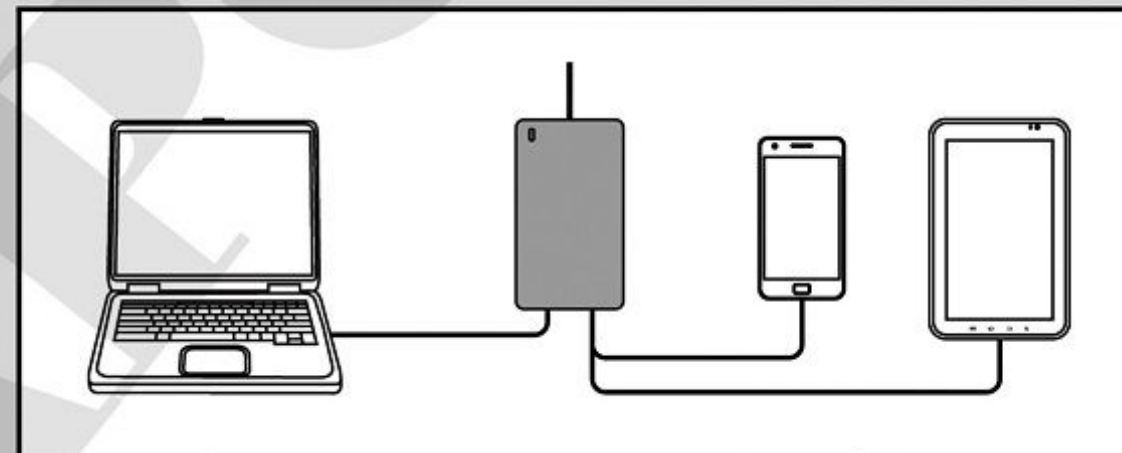

DC Auto Adapters

Model: DC091B.005
 Input: DC 12V
 Output: DC 15-17V
 Power: 90W
 Size: 51 x 30 x 106 mm

Model: DC091B.006
 Input: DC 12V
 Output: DC 18-20V
 Power: 90W
 Size: 51 x 30 x 106 mm



Model: DC120B.002
 Input: DC 12V
 Output: DC 15-17V
 Power: 120W
 Size: 60.9 x 30.7 x 122 mm

Model: DC120B.003
 Input: DC 12V
 Output: DC 18-20V
 Power: 120W
 Size: 60.9 x 30.7 x 122 mm



CORDLESS POWER TOOLS BATTERY PACKS



We provide a wide range of brands for your choice:
AEG, Black & Decker, Bosch, Craftsman, DeWalt, Firestorm, Hitachi, Makita, Milwaukee, National, Panasonic, Paslode, Ryobi, Skil, etc.

Li-ion Battery Type



For Hitachi



For Craftsman



For Festool



For Metabo



For Paslode



For DeWalt

CORDLESS POWER TOOLS & LITHIUM REPLACEMENT BATTERY PACKS

Ni-Cd / Ni-MH Battery Type



For Black & Decker



For Hilti



For Metabo



For Milwaukee



For AEG



For Hitachi

Universal Power Tools Battery Charger

ACMT Series Charger

New Design



+



we provide different connection bases



=



=



Specifications

Model:	ACMT050	ACMG100
Input:	100-240V / 1.2A Max.	
Output:	7.2-18.0V / 3A Max.	20-36V / 3A Max.

Application for Ni-Cd/Ni-MH & Li-ion Power Tools Battery Use different connection bases to fit different batteries



Dual USB Output Ports

* All brands, trademarks and registered trademarks are the property of their respective holders



FUNCTION COMPARISON

PortaPower Design

VS

Original Design

- ✓ Designed with cell voltage monitoring mechanism.
- ✓ Built-in protection IC and NTC to stop battery from being over-charged.
- ✓ Explosion avoided.

- ✗ No cell voltage monitoring system.
- ✗ Chance of being over-charged.
- ✗ Risk of explosion.

**Greater Protection •
More Safety • Better Design**

Battery Pack Circuitry Improvement

In order to solve the shortcomings of original pack design. PortaPower has upgraded their circuitry design to improve the safety protection.

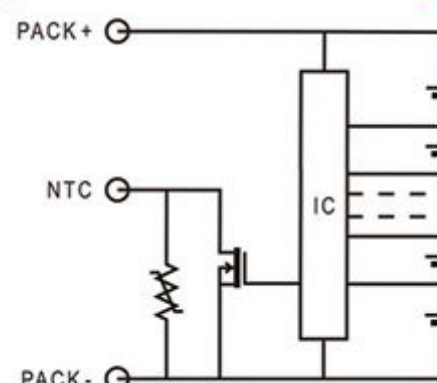
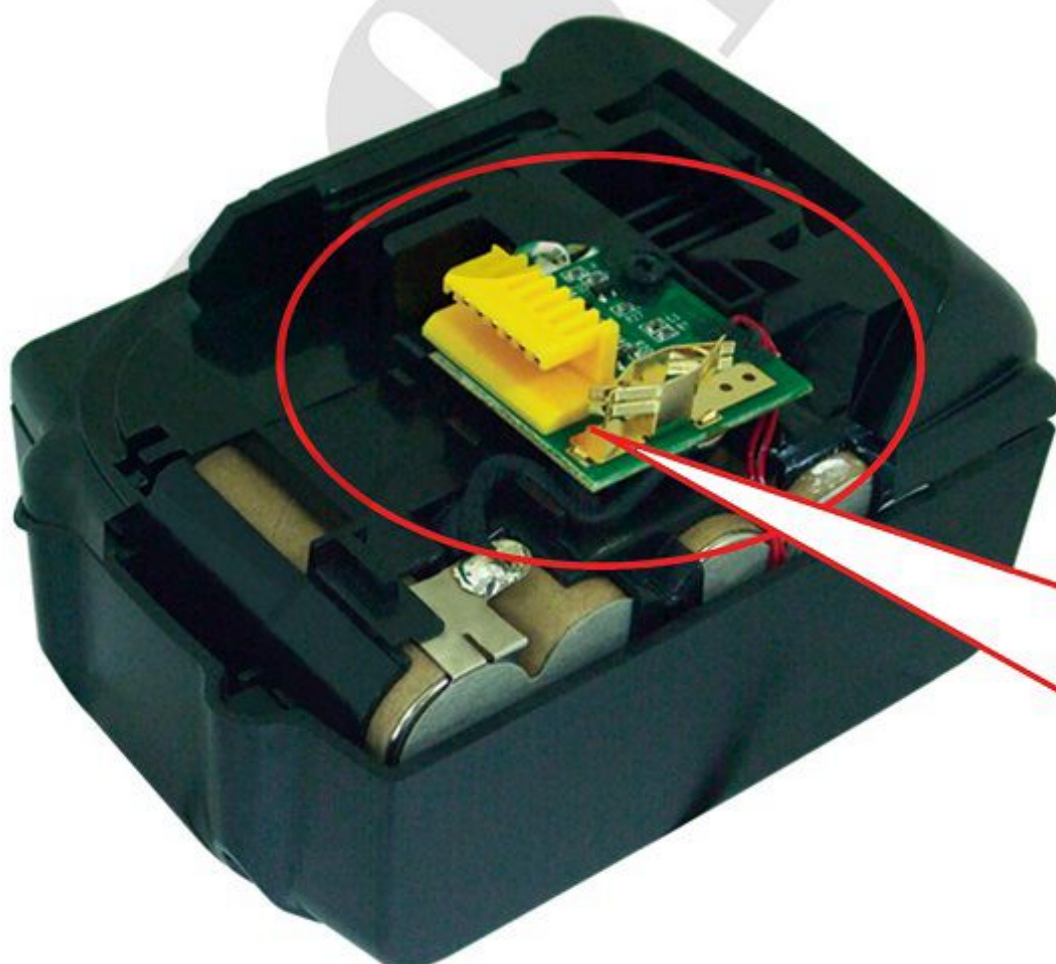

Special Charging Channel:

- Independent charging socket.
- Charging with specified AC power adapter.



PortaPower Design

DIGITAL CAMERA BATTERY PACKS



We provide a wide range of brands to choose:

BenQ, Canon, Casio, Epson, Fujifilm, HP, JVC, Kodak, Leica, Nikon, Olympus, Panasonic, Pentax, Ricoh, Samsung, Sanyo, Sigma, Sony, Toshiba, etc.



For GoPro



For Olympus



For Canon



For JVC



For Sony



For Nikon

*All brands, trademarks and registered trademarks are the property of their respective holders

VIDEO CAMCORDER BATTERY PACKS



We provide a wide range of brands to choose:
Canon, Hitachi, JVC, Panasonic, Samsung, Sanyo, Sharp, Sony, Toshiba, etc.



For Sony



For JVC



For Panasonic



For Canon



For Samsung



For Nikon

PROFESSIONAL CAMCORDER BATTERY PACKS



Flame Test For Our V0 Grade Plastic Specimen

All our Digital Camera and Camcorder battery casings are made with flame-retardant UL 94, V0 grade plastic materials

What is UL 94?

UL 94 is a plastic flammability standard released by Underwriters Laboratories of the USA. The standard classifies plastics according to how they burn in various orientations and thicknesses.

What are the requirements of V0 grade?

If the plastic specimen reach V0 grade, they must:

- Specimen must not burn with flaming combustion for more than 10 seconds after either test flame application.
- Total flaming combustion time must not exceed 50 seconds for each set of 5 specimens.
- Specimen must not burn with flaming or glowing combustion up to the specimen holding clamp.
- Specimen must not drip flaming particles that ignite the cotton.
- No specimen can have glowing combustion remain for longer than 30 seconds after removal of the test flame.

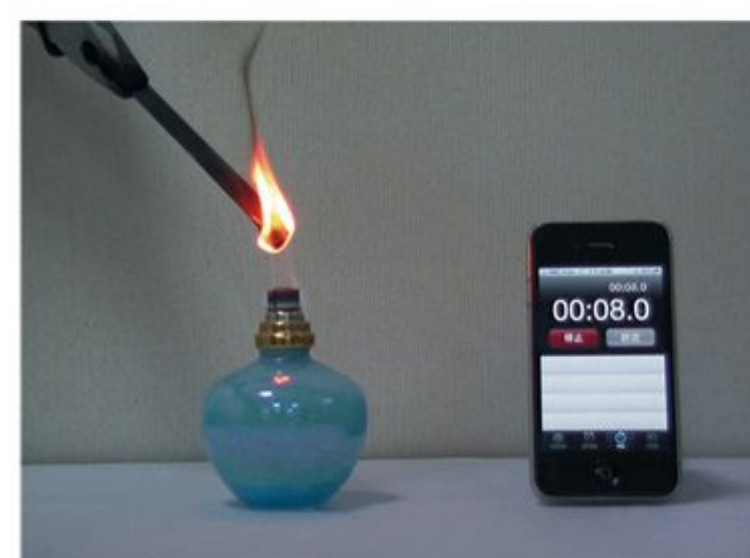

Specimen burns for 10 seconds

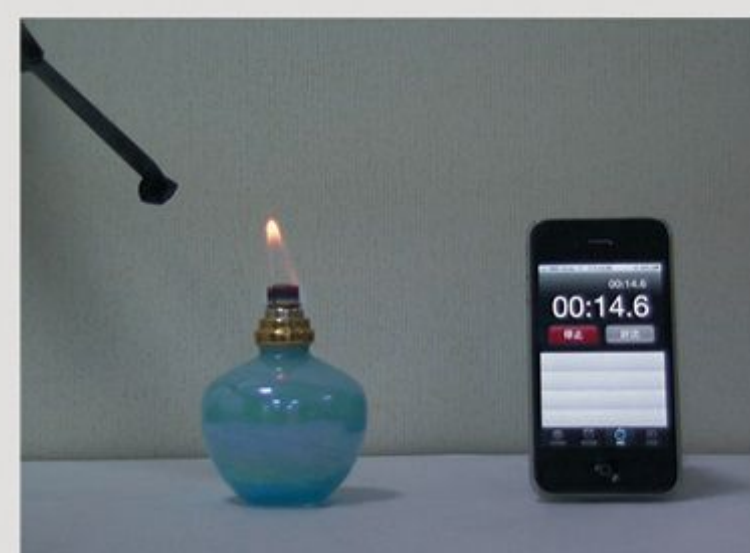

Specimen moves away from the flame, the burning plastic specimen flame extinguishes within 5 seconds

RECHARGEABLE LITHIUM BATTERIES & CHARGERS FOR CAMERAS

Li-Fe Batteries



Rechargeable CR2



Rechargeable CR123A



Rechargeable CR-V3



Rechargeable 2CR5



Rechargeable CR-P2



Clamshell Packing:

Feature

- New Chemistry Li-Fe Lithium batteries
- Long cycle life: 2000 times
- Stable and Safe

Battery Chargers

ACFRB Spec.

Input: 100-240V ;
50Hz/60Hz
Output: DC 3.7V or 7.3V
Size: 80 x 48 x 28 mm



For RCR2



For RCR123A



For RCR-V3



For R2CR5



For RCR-P2

Interchangeable Charger Adapter Plate
There are 5 adapter plates available.

Convenient Design

- Interchangeable AC plugs, designed for worldwide applications
- Direct plug-in to the wall outlet

CAUTION: Not for use with any primary camera lithium battery or other brand rechargeable lithium battery.

Clamshell Packing



MOBILE, SMARTPHONE & PDA BATTERY PACKS



We provide a wide range of brands to choose:

Acer, Asus, BlackBerry, Dell, HP, HTC, LG, Motorola, Nokia, Panasonic, Samsung, Sony Ericsson, Toshiba, etc.

PDA & Smartphone



For BlackBerry



For Dell



For Samsung

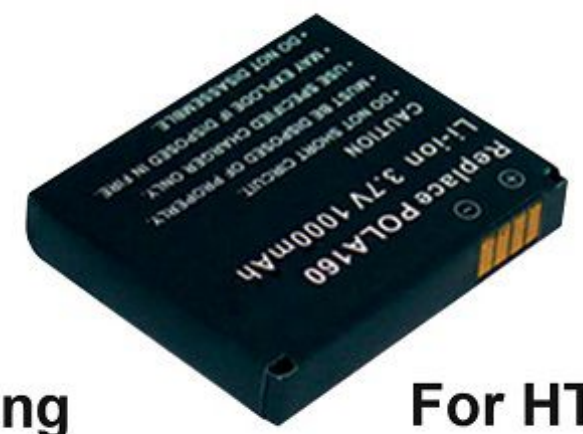

For HTC

Mobile Phone



For Motorola



For Nokia

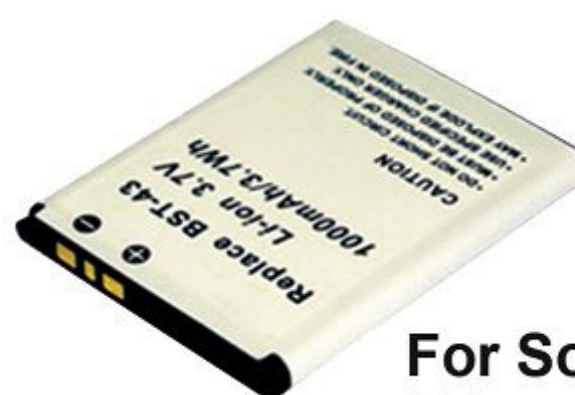

For Sony
Ericsson



For LG

WIDE RANGE OF SMARTPHONE BATTERIES



All our smartphone battery models will be available in high capacity close to the original batteries

PP Code	Original Code	Fit For	Original Cap	Our Cap
BL0950	B600BE	Galaxy S4	1500mAh	1500mAh
BL0816	EB-L1M7FLU	Galaxy Ace 2	1500mAh	1500mAh
BL0853	EB564465LU	Galaxy Beam	1500mAh	2000mAh
BL0971	EB595675LE	Galaxy Note 2	3100mAh	3100mAh
BL1303	BP-3L	Asha 303	1300mAh	1300mAh
BL2625	BA600	Xperia U	1300mAh	1300mAh

EXTERNAL BATTERY MUSIC SERIES

Portable Power Bank designed for use with iPod, iPhone, Smartphone, and all digital devices which run on DC 5V. It is also a portable speaker, MP3 player and LED flashlight. Its compact size and light weight can provide maximum convenience to carry during traveling, cycling, camping and other indoor / outdoor activities.



Specifications

Model:	EL560
Input Port:	Micro-USB
Rated Input:	DC 5V/1A Max.
Output Port:	USB
Rated output:	DC 5V/1A Max.
Size:	124 x 47 x 39 mm
Capacity:	5200 mAh
Cell:	Samsung ICR18650-26F x 2

Model EL560 Max. 5200 mAh

Functions

- **An External DC 5V/1A Power Bank**
 - Built-in 2pcs of rechargeable Li-ion 18650 cell
 - High 5200mAh capacity for long run time
 - Built-in safety protection circuit for maximum protection
- **A Portable Hi-Fi Speaker**
 - Using standard 3.5mm audio line-in jack for maximum convenience
- **An MP3 Player**
 - Support up to 32GB TF card (Micro-SD) as music source
- **A LED Flashlight**
 - Built-in super-white LED light for general use



Control Panel



- 3.5mm Audio Line-in Socket
- Super-white LED Flashlight
- DC 5V Power Output Socket
- TF Card (Micro-SD) Socket
- Micro-USB Input Socket

EXTERNAL BATTERY MINI SERIES

Specifications

Model	EL571
Input Port	Micro-USB
Rated Input	DC 5V/1A Max.
Output Port	USB
Rated Output	DC 5V/1.5A Max.
Size	Ø27 x 97 mm
Capacity	3400 mAh
Cell	Panasonic NCR18650B



Package Include

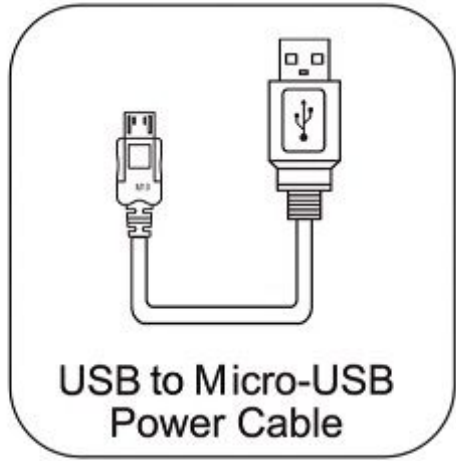

Colors :
Green, Blue, Yellow, Red, Pink, White, Black



Model EL571 & EL581 Max. 3400 mAh



Colors : Grey & Red



Specifications

Model	EL581
Input Port	Micro-USB
Rated Input	DC 5V/1A Max.
Output Port	USB
Rated Output	DC 5V/1.5A Max.
Size	Ø27 x 97 mm
Capacity	3400 mAh
Cell	Panasonic NCR18650B

Package Include

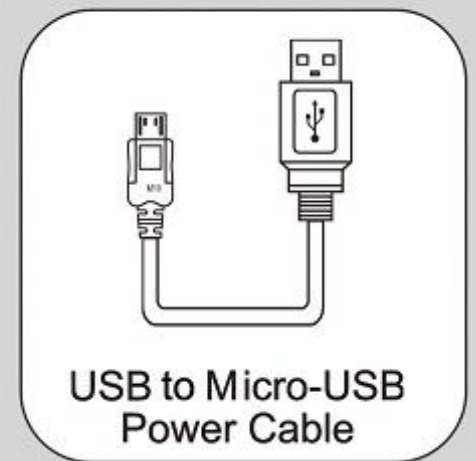

EXTERNAL BATTERY MINI SERIES

Features

- **5V USB Power Output**
- **5V Micro-USB Charging Port**
 - Compatible with current popular smartphone chargers which use Micro-USB plug.
- **A LED Flashlight**
 - Hold the function switch for 3 seconds to turn on and off the LED flashlight.



Optional Accessories:



USB Adapter



Cigarette Lighter Plug 1 Port and Dual USB Car Charger

Convenient Design

- Pocket-size, available in 4 colors.
- Battery charging through computer USB socket.
- USB output socket lets you to use the device's own USB cable.
- Uses the supplied USB cable with our wide range connector plugs compatible with over 90% of mobile devices.



EL509 Max. 2000 mAh



Specifications

Model:	EL509
Input:	DC 5V/1A Max.
Output:	DC 5V/1A Max.
Size:	81 x 48 x 12 mm
Capacity:	2000 mAh
Cell:	Panasonic CGA-E/T03SEA

EXTERNAL BATTERY FASHION SERIES

Specifications

Model:	EL531	EL541
Input Port:	Micro-USB	
Rated Input:	DC 5V/1.5A Max.	DC 5V/2A Max.
Output Port:	Dual USB	
Rated Output:	DC 5V/2.1A Max.	DC5V/3.1A Max.
Size:	71 x 63 x 23 mm	90 x 71 x 29 mm
Capacity	6800mAh	13400mAh
Cell	Panasonic NCR18650B	



Model EL 531 Max. 6800 mAh

Model EL541 Max. 13400 mAh



Package Includes

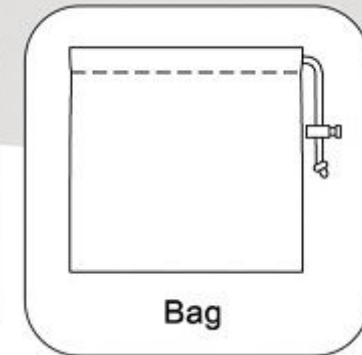
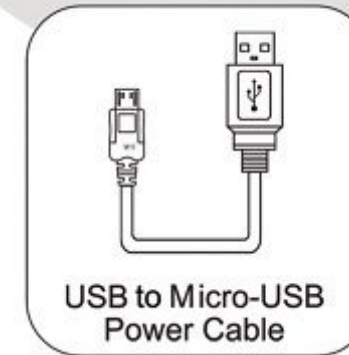

Features

- Dual USB Output Ports
- Can use proprietary USB cable
- Optional multi-connector tips for choose
- 5-level LED Indicator
- Can charge 2 devices simultaneously
- Micro-USB Charging Port
- Can charge via computer USB terminal
- Also can charge via your original devices charger
- A bright white LED flashlight
- Power-saving function



EXTERNAL BATTERY LEISURE SERIES

Specifications

Model:	EL586
Input: (I)	Micro-USB Port (DC 5V/1A)
(II)	USB Cable (DC 5V/1A)
Output: (I)	Micro-USB Cable (DC 5V/1A)
(II)	USB Port (DC 5V/2.1A)
Size:	120 x 80 x 18 mm
Capacity:	10000 mAh
Cell:	YLE Polymer



4 Colors : Pink, Blue, Green & Deep Gray



Package Include

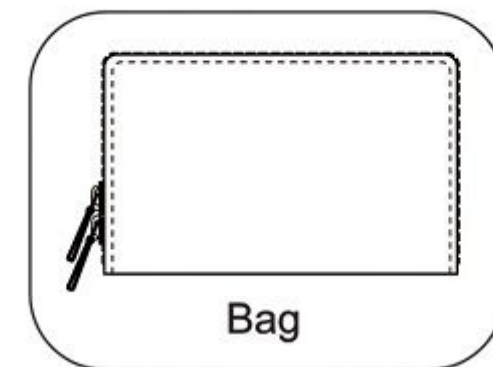
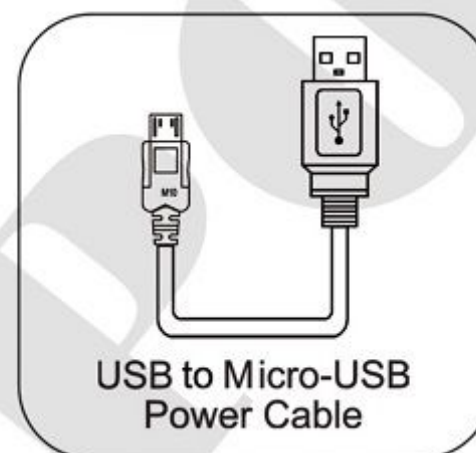

Model EL586 Max. 10000 mAh

Features

- **Dual Power Input**
 - Micro-USB Port : 5V / 1A ;
 - USB Cable : 5V / 1A
- **Dual Power Output**
 - Micro-USB Cable : 5V / 1A ;
 - USB Port : 5V / 2.1A
- **A LED Flashlight**
 - Hold the function switch for 3 seconds to turn on and off the LED flashlight.
- **High Capacity**
- **Small Size**



EXTERNAL BATTERY TRAVEL SERIES

Specifications

Model:	EL1697	
Input:	DC 12V - 24V	
Output:	1.	16V= 4A /
		19V= 3.5A /
		24V= 2.5A
	2.	5V= 1A
3.	5V= 2.1A	
	4.	10.8V= 5A
Size:	177 x 110 x 23 mm	
Capacity:	27000 mAh	
Cell:	Panasonic NCR18650A x 9	



4 Colors : Pink, Green, Blue & Gray



Model EL1697 Max. 27000 mAh

Features

- Slow charge via computer USB socket.
- Fast charge with supplied charger.
- 4 output work simultaneously.
 - Output I : 3 Selectable voltage output - 16V/4A, 19V/3.5A & 24V/2.5A
 - Output II : 5V/1A,
 - Output III: 5V/2.1A,
 - Output IV: 10.8V/5A,
- High Capacity: 27000mAh Max.

Package Includes



Connectors for Laptop



Connectors for Mobile Phone



AC Adapter (19V / 45W)



Travel Bag



Cigarette Plug

Optional Accessory:



DC Adapter (19V / 90W)



Output 9-12V



Output 5V



Output 16V, 19V & 24V

EXTERNAL BATTERY BUSINESS SERIES



Specifications

Model:	EL1692
Rated Input:	DC16-25V
Selectable Output:	DC16V or 19V
Output:	7.8A Max.
USB Output:	DC5V/0.5A
Size:	233 x 169 x 14 mm
Capacity:	7800 mAh
Cell:	Panasonic CGA-E/T03SEA x 4

Model EL1692 Max. 7800 mAh

Features

- Ultra slim (14mm thick) and light weight (0.75kg) design.
- 16V and 19V selectable voltage output.
- 87Wh high power.
- 4-stage power indicator
- Suitable for laptop computer use.



Accessories:



Connectors for Laptop



AC Adapter



EXTERNAL BATTERY PROFESSIONAL SERIES



Specifications

Model:	EL1901
Rated Input:	DC 12-19V
Selectable Output:	DC 16V or 19V 4.75A Max.
USB Output:	DC 5V/0.5A
Size:	270 x 145 x 33 mm
Capacity:	40500 mAh
Cell:	Panasonic CGR18650CG x 18

Model EL1901 Max. 40500 mAh

Features



Multiple DC Ports



Output voltage selection



4-stage LED indicators



With power indicator to show the battery capacity



Can charge 2 devices simultaneously

REPLACEMENT LED-FLASHLIGHT BATTERY

**High Capacity
real Needs**



FL1843 battery functions as 3 x AAA cells in cartridge



FL1843

Feature

• High Safety Design

- Batteries are built with reliable safety Protection Circuit Modules (PCM) to protect the FL1843 battery: from Over Charge / Over Discharge / Overload / Under Voltage

• Light Weight

- 26% lighter than 3 x AAA batteries in cartridge

• LED Charge Indicator

- Steady blue: 100% - 70%
- Flashes blue: 69% - 30%
- Slow flashes red: 29% - 10%
- Quick flashes red: <10%

Specifications

Model No.	FL1843B.142	FL1843B.184
Voltage	3.6V	
Capacity	750mAh/2.70Wh	1400mAh/5.04Wh
Discharge Current(1C)	0.75A	1.4A
Max. Discharge Current	2A (+/- 0.5A)	
Cycle Life	500 - 700	
Size	Ø23.0 x 64.0 mm	



FL1843B.142
Weight: 30.6g



3 x AAA & Cartridge
Weight: 41.6g

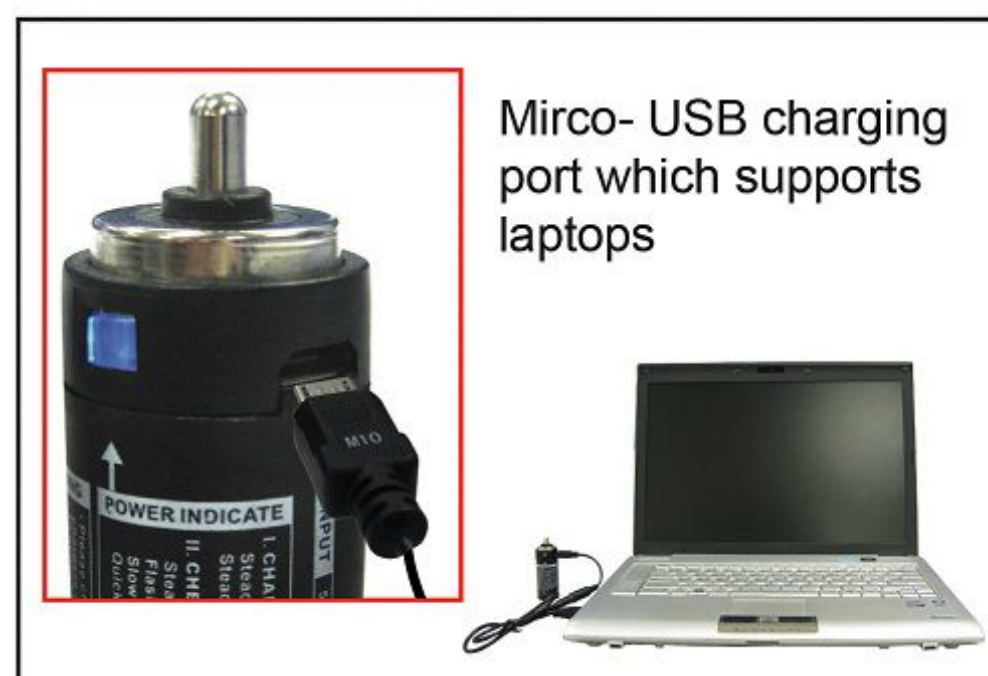

Mirco- USB charging port which supports laptops

BATTERY DESIGN



Design 1
+ nub cylinder end
- flat opposite end
Pack with PVC jacket



Design 2
One end center
Anode (+) & outer
ring Cathode (-);
Other end flat
Cathode (-)
Pack with PVC jacket



Design 3
+ nub cylinder end
- flat opposite end
Pack with ABS
plastic outer casing



Design 4
+ small flat cylinder end
- flat opposite end
Pack with ABS plastic
outer casing



Design 5
One end center Anode (+)
& outer ring Cathode (-);
the end flat Cathode (-)
Pack with ABS plastic outer
casing

Special Design

Both sides have
**Anode (+) in center &
Cathode (-) on outer
circle**

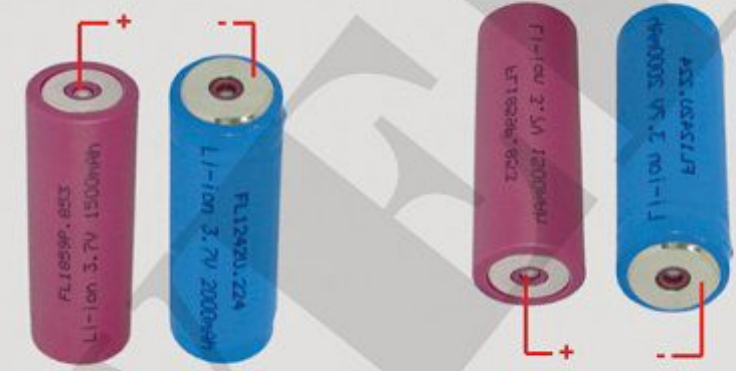

Coated with ABS plastic
outer casing or PVC jacket



Design 6
Both sides are
Anode (+) in center &
Cathode (-) on outer ring
Pack with ABS plastic
outer casing



Design 7
+ nub cylinder end
- flat opposite end
*Replace 3 x AAA
flashlight battery cartridge
Pack with ABS plastic
outer casing

Specifications of Available Models

Design	Model	Standard Voltage	Capacity	Discharge Voltage	Discharge End Voltage	Discharge Current (1C)	Max. Discharge Current	Dimension
1	FL143U.142	3.7V	750mAh	4.2V~3.0V	3.0V	0.75A	2.5A (+/-0.5A)	Ø14.6 x 50 mm
	FL145U.154	3.7V	800mAh	4.2V~3.0V	3.0V	0.8A	2.5A (+/-0.5A)	Ø14.6 x 57 mm
	FL166U.266	3.7V	3500mAh	4.2V~3.0V	3.0V	3.5A	7.0A (+/-0.5A)	Ø26.6 x 72 mm
	FL175U.764	3.7V	1600mAh	4.2V~3.0V	3.0V	1.6A	2.5A (+/-0.5A)	Ø17.2 x 57 mm
	FL185U.853	3.7V	1500mAh	4.2V~3.0V	3.0V	1.5A	7.0A (+/-0.5A)	Ø18.6 x 57 mm
	FL186U.083	3.7V	2200mAh	4.2V~3.0V	3.0V	2.2A	7.0A (+/-0.5A)	Ø18.6 x 72 mm
2	FL1853U.853	3.7V	1500mAh	4.2V~3.0V	3.0V	1.5A	4.0A (+/-0.5A)	Ø18.6 x 57 mm
	FL1863U.083	3.7V	2200mAh	4.2V~3.0V	3.0V	2.2A	4.0A (+/-0.5A)	Ø18.6 x 72 mm
3	FL1667P.266	3.7V	3500mAh	4.2V~3.0V	3.0V	3.5A	4.0A (+/-0.5A)	Ø28.2 x 72 mm
	FL1857P.853	3.7V	1500mAh	4.2V~3.0V	3.0V	1.5A	4.0A (+/-0.5A)	Ø20.2 x 57 mm
	FL1867P.083	3.7V	2200mAh	4.2V~3.0V	3.0V	2.2A	4.0A (+/-0.5A)	Ø20.2 x 72 mm
4	FL1856P.853	3.7V	1500mAh	4.2V~3.0V	3.0V	1.5A	4.0A (+/-0.5A)	Ø20.2 x 57 mm
5	FL1668P.266	3.7V	3500mAh	4.2V~3.0V	3.0V	3.5A	4.0A (+/-0.5A)	Ø28.2 x 72 mm
	FL1858P.853	3.7V	1500mAh	4.2V~3.0V	3.0V	1.5A	4.0A (+/-0.5A)	Ø20.2 x 57 mm
6	FL1868P.083	3.7V	2200mAh	4.2V~3.0V	3.0V	2.2A	4.0A (+/-0.5A)	Ø20.2 x 72 mm
	FL1859P.853	3.7V	1500mAh	4.2V~3.0V	3.0V	1.5A	4.0A (+/-0.5A)	Ø20.2 x 57 mm
	FL1869P.083	3.7V	2200mAh	4.2V~3.0V	3.0V	2.2A	4.0A (+/-0.5A)	Ø20.2 x 72 mm
7	FL1455P.154	3.7V	1500mAh	4.2V~3.0V	3.0V	1.5A	4.0A (+/-0.5A)	Ø22.4 x 57 mm
	FL1855P.853	3.7V	1500mAh	4.2V~3.0V	3.0V	1.5A	4.0A (+/-0.5A)	Ø22.4 x 57 mm

FLASHLIGHT BATTERIES CHARGER

AV-HP Series

Input : DC 100-240V~50/60Hz

Output : DC 4.2V / 1A

App : 4 x 18650

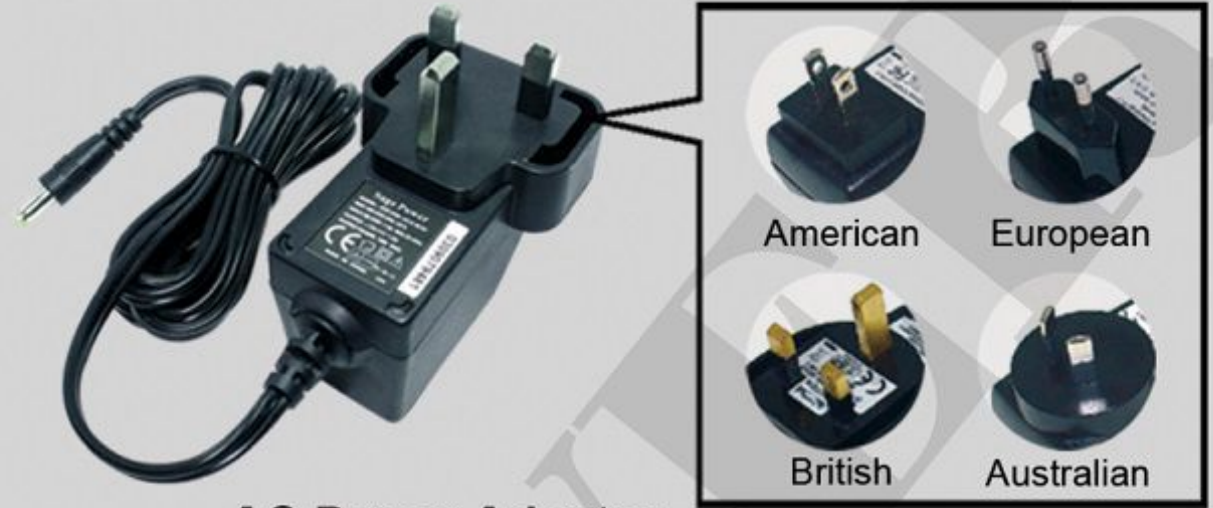

AC Power Adapter



Charger comes with two power adapters, allowing you to charge your battery at home or in car.

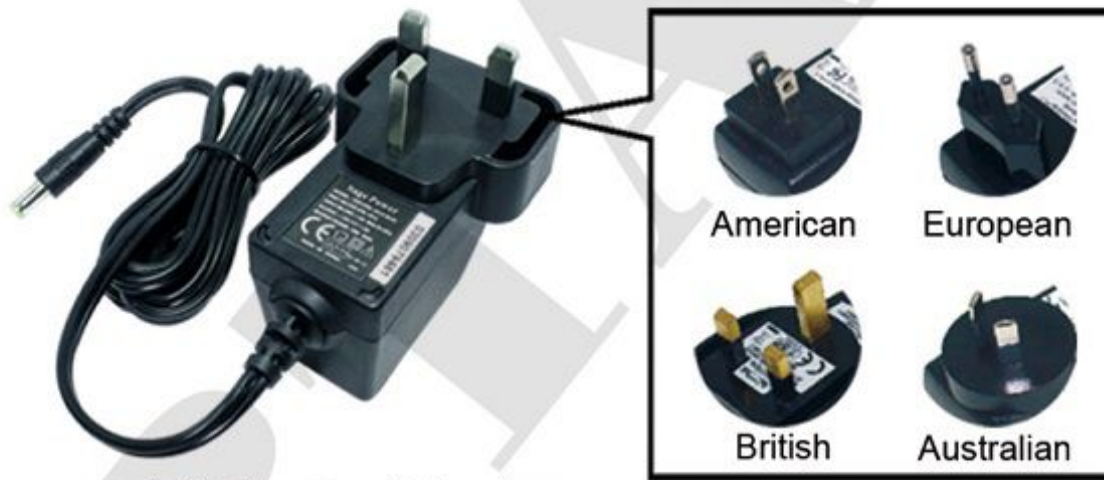

AC Power Adapter

AV-GP Series

Input : DC 100-240V~50/60Hz

Output : DC 4.2V / 1A



AC-MP Series

Input : 100-240V~50-60Hz

Output : DC 4.2V / 500 mA

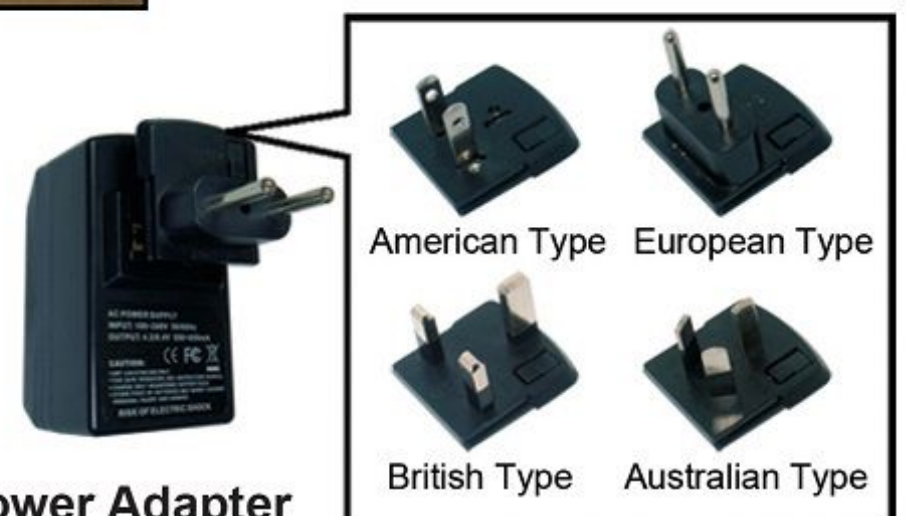

AC Power Adapter



UNIVERSAL CHARGERS FOR DC & DV BATTERY

AVEQ Series

For 3.6V~4.2V



New Design

AVEQ Spec.

Input: DC 5V/1A
Output: DC 4.2V / 1A
Dimension: 79 x 47 x 22 mm

Power by USB Port

Connect the charger USB plug to any USB power socket like **PC Computer, USB Travel Charger, USB Car Charger and External Battery.**

Interchangeable Charger Plates

Suitable for different battery models, simply change the charger plate.

Package Includes



AVET Series

For 7.2V~8.4V



AVET Spec.

Input: DC 5V / 1A
Output: DC 8.4V / 1A
Dimension: 86 x 49 x 24 mm



Convenient Design

- Slim and Portable size
- With Micro-USB Port, connect any USB output socket to get power



UNIVERSAL CHARGERS FOR DC & DV BATTERY

Power by USB Port

Connect the charger USB plug to any USB power socket like **PC Computer, USB Travel Charger, USB Car Charger and External Battery.** The AVEP charger will get power from the USB socket and start charging your Digital Camera battery.

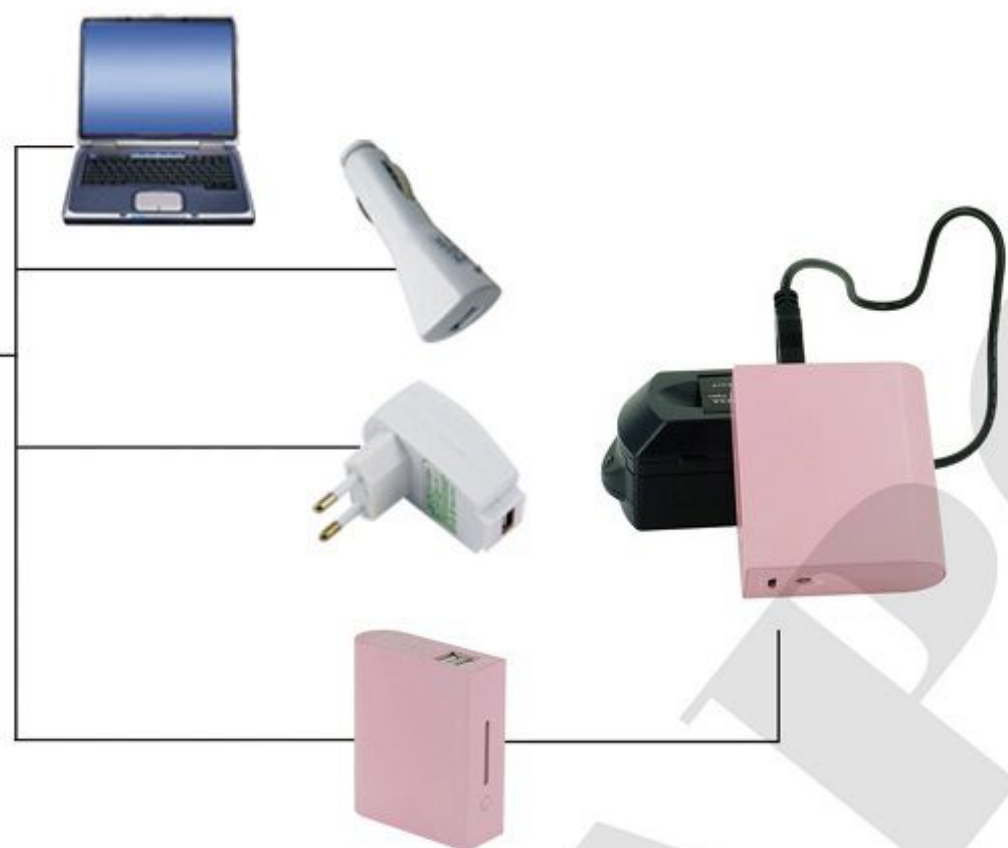

AVEP Series



AVEP Spec.

Input: DC 5V
 Output: DC 4.2V
 Operation Current: 500mA
 Dimension: 86 x 49 x 24 mm

AVCP Series



Interchangeable Charger Adapter Plate

Suitable for different battery models, simply change the charger plate.

AVCP Spec.

AC Adapter Input:
 100-240V ; 50Hz/60Hz
 AC Adapter Output:
 DC 12V / 0.5A
 Charger DC Output:
 DC 4.2V or 8.4V
 Dimension: 86 x 49 x 24 mm

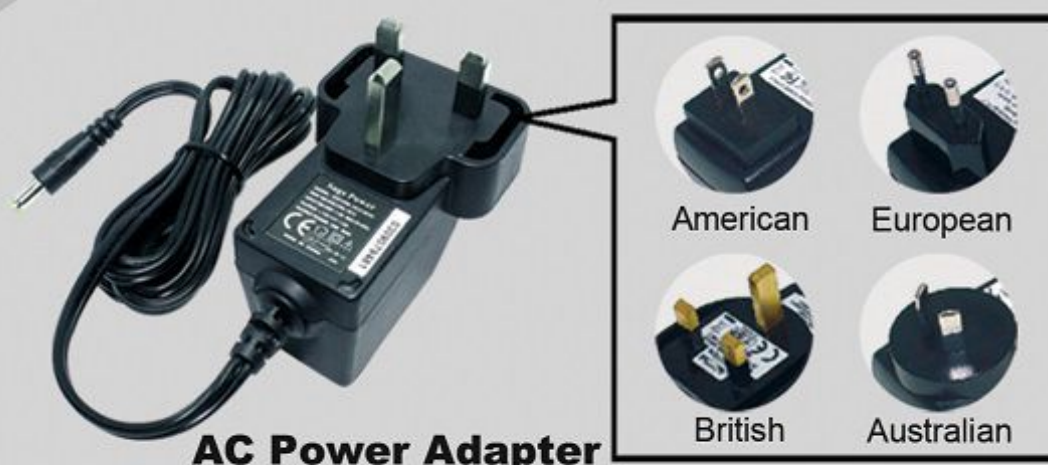

AC Power Adapter



Cigarette Plug



At Home



In Car

Conveniently

Charger come with two power adapters, allow you to charge your battery at home or in car.

UNIVERSAL CHARGERS FOR DC & DV BATTERY

Convenient Design

- Direct plug into the wall outlet
- Compact design
- Interchangeable AC plugs, design for worldwide applications



ACMPB Series



ACMPB Spec.

Input:
100-240V ; 50Hz/60Hz
Output:
DC 4.2V or 8.4V
Dimension:
80 x 48 x 28 mm

Interchangeable Charger Adapter Plates

Plate Suitable for different battery models, simply change the charger plate.



AVMP Series



Interchangeable Charger Adapter Plate

Suitable for different battery models, simply change the charger plate.

AVMP Spec.

AC Adapter Input: 100-240V ; 50Hz/60Hz
AC Adapter Output: DC 12V / 1A
Charger DC Output: DC 4.2V or 8.4V
Dimension: 106 x 68 x 35 mm

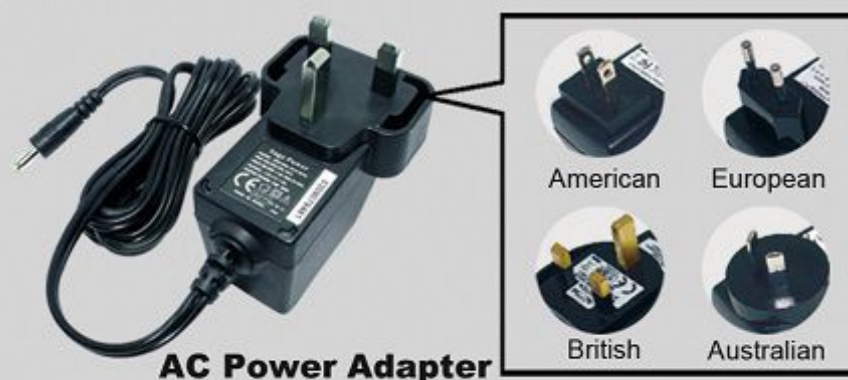

AC Power Adapter



DC Car Cord

Conveniently

Charger come with two power adapters, allow you to charge your battery at home or in car.



At Home



In Car

PROFESSIONAL CAMCORDER CHARGERS

Fit for V-Mount Style Batteries



4-Channel V-Mount Battery Charger



2-Channel V-Mount Battery Charger

Fit for NP Style Batteries



4-Channel Sequential Battery Charger

Fit for V-Mount Style Batteries



2-Channel Gold Mount Battery Charger

POWER TO THE

POWER TO THE PORTABLE

THE PORTABLE

HONG KONG HEADQUARTER:

PORTAPOWER (China) Limited

PORTAPOWER (HK) Limited

Flat 1003, 10/F., Hopeful Factory Ctr., 10-16 Wo Shing St.,
Fotan, N.T., Hong Kong

Tel: (852) 2687 6323 ; Fax: (852) 2687 6312

Website: <http://www.portapower.com>

MACAU OFFICE:

PWS (Macao Commercial Offshore) Limited

Alameda Dr. Carlos D'Assumpção, n.º160, Edif. Tong Nam
Ah Central Comércio 13.º andar, A, Macau

Tel: (853) 2872 3513, 2872 3526 ; Fax: (853) 2872 3512

Website: <http://www.pws.com.mo>

PANYU FACTORY:

Guangzhou Zhanhui Electronics Co. Ltd

Shinan Road, Guantan, Dongchong, Panyu District,
Guangzhou

Tel: (86) 020-3491 0222, 3490 2256 ;

Fax: (86) 020-3491 0333

HUNAN FACTORY:

PORTAPOWER (Changde) Industrial Zone Limited

Anxiang Country Industrial Area, Changde City,
Hunan Province

Tel: (86) 0736-433 8338 ; Fax: (86) 0736-433 8333